

Backwater lifting station Ecolift DN 100, Floor slab, black

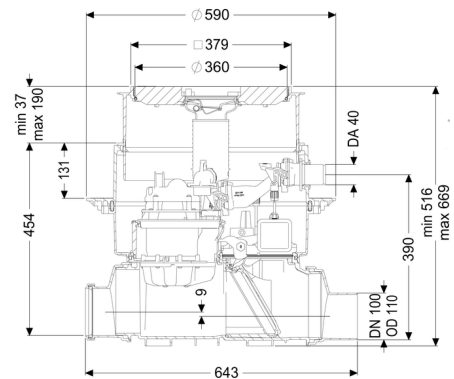

Article information

Item no.: 21100S
 GTIN: 4026092046807
 Price group: 20

Advantages

- Hybrid function: uses the natural fall to the sewer - pump is only used in case of backwater
- Quiet and energy-saving
- Double safety due to backwater flap and pressure pipe

Description

The backwater lifting station for faecal and non-faecal wastewater is equipped with one pump and one motor-driven closure system.

The pipe cross-section is normally open and the water drains to the sewer via natural fall. Backwater is detected by an optical probe, which causes the motor-driven closure system to close automatically. During the backwater phase, the water drains via a pressure pipe, which carries the wastewater above the backwater level and into the sewer.

Connection hole in the drain body for installation in the ground, incl. seal for pressure pipe and cable conduit.

The station is controlled by a user-friendly control unit, which is optionally integrated in the building management system via a potential-free contact, or alarm and collective fault messages can be output via a GSM interface.

Type of wastewater: wastewater with sewage
 Installation situation: floor slab installation

Version:

Odour trap: Multistop
 Emergency closure: yes

Pump control:	Control unit
Passage seal for conduit pipe (DN):	50 mm
Delivery state:	Pre-mounted for final assembly on site (pumps and sensor system must be fitted on site and control unit must be connected)
Number of motor-driven backwater flaps:	1

General characteristics:

Nominal size (DN):	100
Outer diameter (OD):	110
Colour:	black
Approval:	Z-53.2-487

Dimensions:

Length:	642 mm
Width:	590 mm
Cutout dimension, length:	750 mm
Cutout dimension, width:	750 mm

Tank:

Pressure pipe connection (OD):	40 mm
Installation depth:	486 - 640 mm
Groundwater resistant from lower edge of base section:	3,000 mm
Nominal pressure (PN):	6

Drain body:

Socket version:	including spigot and socket
Vertical adjustment:	vertically adjustable upper section

Coverage features:

Type of cover:	Cover plate with slotted cover
Cover material:	Polymer
Colour of cover:	black
Drainage function:	yes
Load class:	L 15 (EN 1253-1)
Length:	366 mm
Width:	366 mm

Locking: Lock & Lift

Pumping device:

Pump:	SPZ 1000
Number of pumps:	1
Max. pumping capacity:	11.5 m ³ /h
Max. pumping height:	10 m
Operating mode:	S3 - 50 %
Power P1:	1.2 kW
Power P2:	0.69 kW
Speed:	2,800 U/min
Type of fuse required (electrical protection):	C 16 A
Max. temperature (permanent) of conveyed material:	40 °C
Connection type:	coded plug
Weight:	10 kg
Impeller type:	Macerator
Length of mains cable for pump:	5 m
Rated current:	5.2 A
Protection class (pump):	IP 68 (3m/48h)
Protection class:	I
Type of pump connection cable:	H07RN-F 3G 1.0 mm ²
Temperature monitoring:	integrated
Cos phi - power factor:	0.97
Insulation class:	F
Vertical drop between inlet and outlet:	9 mm
Motor type:	KSM 140
Protection class motor:	IP 68 (3m/48h)
Protection class probe:	IP 68 (3m/48h)

Control:

Control unit:	Comfort
Operating voltage:	230 V
Mains frequency:	50 Hz
Self-diagnosis system (SDS):	yes
Battery buffering:	yes
Multi-line display:	yes
Log book function:	yes
USB interface:	no
GSM interface:	no
Potential-free contact:	yes
Standby power:	5 W
Protection class control unit:	IP 54
Length of mains cable for control unit:	1.4 m
Type of level measurement:	optical
Level measurement instrument:	optical probe

Alarm sensor:

optical probe