

Lifting station Aqualift F Mono Mono, Standard, SPF 1500-S3, Gate valve

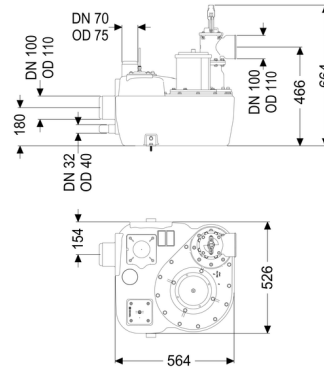
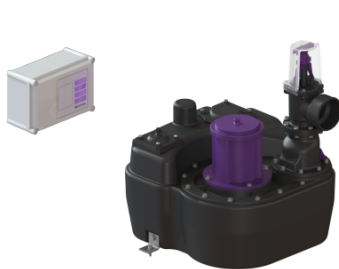

Article information

Item no.: 28644
 GTIN: 4026092007693
 Price group: 20

Advantages

- Different performance classes available
- Pressure sensor for reliable pneumatic level measurement
- Including sound absorption mat

Description

The lifting station for faecal and faecal-free wastewater is equipped with a submersible pump and a backflow preventer. The collection tank made of permanently resistant polymer (PE) offers universal connection options and has a screwed access cover.

The station is controlled by a user-friendly control unit, which can be optionally integrated in the building management system via a potential-free contact or alarm and collective fault messages can be output via a GSM interface (Comfort control unit).

Type of wastewater: wastewater with sewage
 Installation situation: free-standing set-up

Version:

Type of system: Single station
 Shut-off valve: Shut-off valve made of polymer
 Pump control: Control unit
 Backflow preventer: integrated
 Sound absorption mat: yes

Delivery state: Installation-ready (electrical components, connection parts must be connected on site)

General characteristics:

Colour:	black
Standard:	EN 12050-1

Dimensions:

Length:	564 mm
Width:	525 mm
Height:	664 mm

Tank:

Number of inlets:	1 ST
Inlet nominal size (DN):	100
Inlet nominal size (OD):	110 mm
Inlet max. scoring (DN):	150 mm
Distance pipe bottom inlet to tank bottom:	125 mm
Distance from centre of outlet pipe to tank bottom:	466 mm
Distance from centre of inlet pipe to tank bottom:	180 mm
Connection for manual diaphragm pump (DN):	32
Tank volume:	50 l
Pumping volume:	20 l
Pressure pipe connection:	horizontal
Pressure pipe connection (DN):	100 mm
Pressure pipe connection (OD):	110 mm
Venting connection (DN):	70 mm
Free passage:	40 mm

Pumping device:

Pump:	SPF 1500
Number of pumps:	1
Max. pumping capacity:	40 m ³ /h
Max. pumping height:	8 m
Operating mode:	S3 - 50 %
Power P1:	1.4 kW
Power P2:	1.1 kW
Speed:	1,415 U/min
Max. temperature (permanent) of conveyed material:	40 °C
Connection type:	Direct connection
Weight:	24 kg

Impeller type:	Multi-vane impeller
Length of mains cable for pump:	5 m
Rated current:	2.7 A
Protection class (pump):	IP 68 (3m/48h)
Protection class:	I
Type of pump connection cable:	H07RN-F 7G 1.5 mm ²
Temperature monitoring:	integrated
Cos phi - power factor:	0.77
Insulation class:	F

Control:

Control unit:	Standard
Operating voltage:	400 V
Mains frequency:	50 Hz
Self-diagnosis system (SDS):	yes
Battery buffering:	yes
Multi-line display:	no
Log book function:	yes
Potential-free contact:	yes
Type of fuse required (electrical protection):	3 x C 16 A
Motor protection switch:	yes
Protection class control unit:	IP 54
Length of mains cable for control unit:	0 m
Type of level measurement:	pneumatic
Level measurement instrument:	Immersion pipe
Alarm sensor:	Immersion pipe